



**DES PRODUITS
DE QUALITÉS**



**DES MACHINES
MODERNES**



**UN SERVICE
EFFICACE**

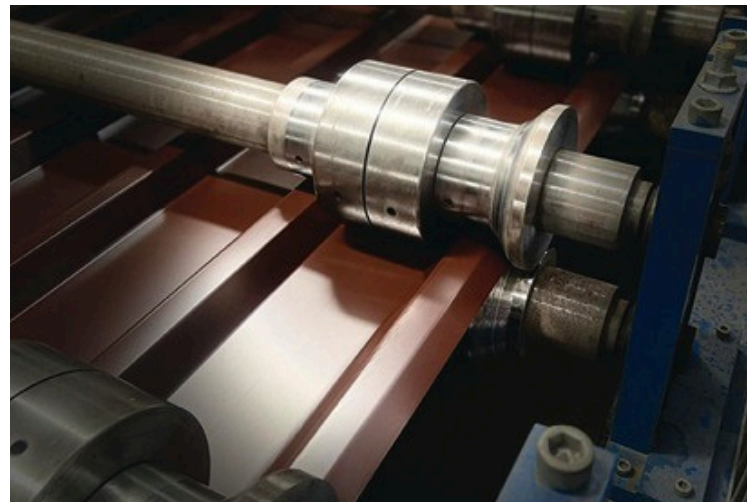

info@construkmania.com



7500 Tournai



+32 491 25 32 58



Uniquement sur rendez-vous du
lundi au samedi

Fiche technique du modèle de tôles disponible au dépôt

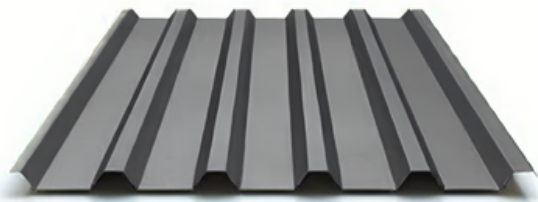

P-35

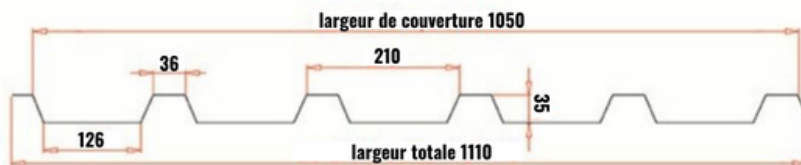

Voici les différentes longueurs disponibles au dépôt avec leurs **prix** respectifs (**hors taxes**) :

ECO P-35 en acier galvanisé gris anthracite RAL 7016 épaisseur 0,4mm:

- 2,00m x 1,10m : 19,70€ la tôle
- 2,50m x 1,10m : 24,63€ la tôle.
- 3,00m x 1,10m : 29,55€ la tôle.
- 3,50m x 1,10m : 34,48€ la tôle.
- 4,00m x 1,10m : 39,40€ la tôle.
- 5,00m x 1,10m : 49,30€ la tôle
- 6,00m x 1,10m : 59,10€ la tôle

PRO P-35 en acier galvanisé gris anthracite RAL 7016 avec feutre anti-condensation épaisseur 0,5mm :

- 3,00m x 1,10m → 42,75€ la tôle
- 3,50m x 1,10m → 49,85€ la tôle
- 4,00m x 1,10m → 57,00€ la tôle
- 5,00m x 1,10m → 71,20€ la tôle

P-35 en **PVC** translucide

- 2,00m x 1,10m → 32,89€ la tôle
- 3,00m x 1,10m → 49,33€ la tôle
- 4,00m x 1,10m → 65,78€ la tôle
- 6,00m x 1,10m → 98,67€ la tôle

Pour toutes autres longueurs, veuillez passer commande

Fiche technique des accessoires disponible au dépôt :

Vis auto perceuse tête hexagonale 48/70mm

Etanchéité assurée par le joint EPDM imputrescible.

- 50 vis --> **12,38€**
- 100 vis --> **24,75€**



Cavalier étanche EPDM

- 50 cavaliers --> **22,73€**
- 100 cavaliers --> **45,45€**

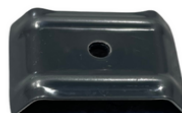

Pour d'autres dimensions, veuillez passer commande

Fiche technique des différents profils disponible au dépôt :

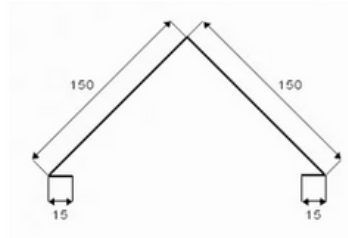

Faitière en acier galvanisé gris anthracite RAL 7016 de 2m disponible en :

- 90° --> **16,50€** htva
- 140° --> **16,50€** htva
- Angle sur mesure --> **21,50€** htva

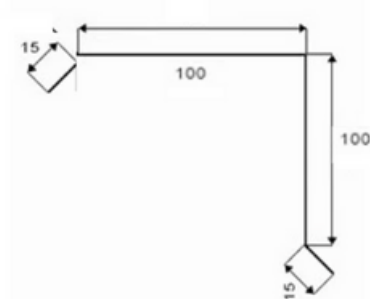
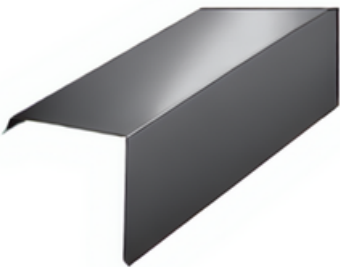

Rive en acier galvanisé gris anthracite RAL 7016 de 2m : **16,50€** htva

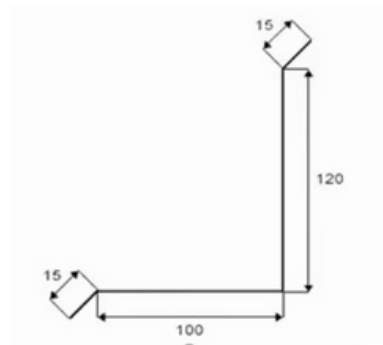
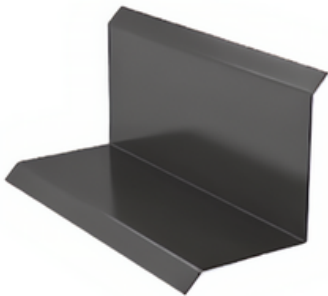

Rive contre mur (pas dessus) en acier galvanisé gris anthracite RAL 7016 de 2m : **16,50€** htva

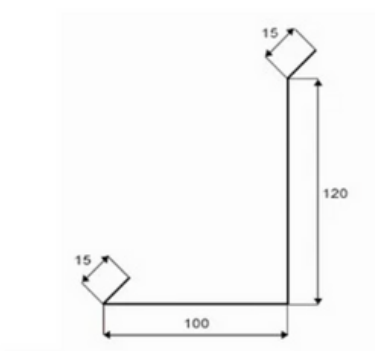
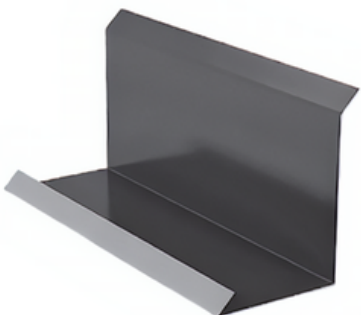

Rive contre mur (pas dessous) en acier galvanisé gris anthracite RAL 7016 de 2m : **16,50€** htva

Nos services de pliage sur mesure

Nous proposons des solutions de pliage sur mesure pour :

- Rives de différentes dimensions
- Faitières sur mesure
- Couvre-murs
- Et bien d'autres produits

Prix sur demande :

Pour obtenir un devis personnalisé, veuillez nous envoyer un schéma détaillé avec les dimensions souhaitées.



Fiche technique d'autre modèle disponible sur commande uniquement (pas en stock à notre dépôt) :

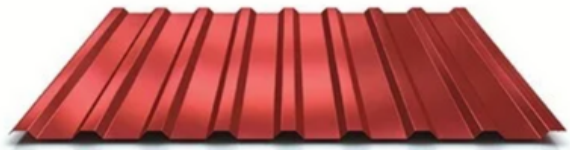

P-18

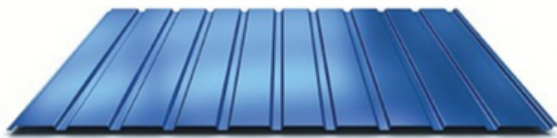
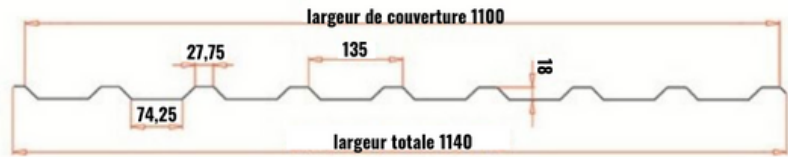

P-8

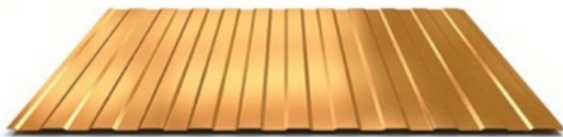

P-4



- AVEC GAUFRAGE
- SANS GAUFRAGE





P-I
Disponible en module

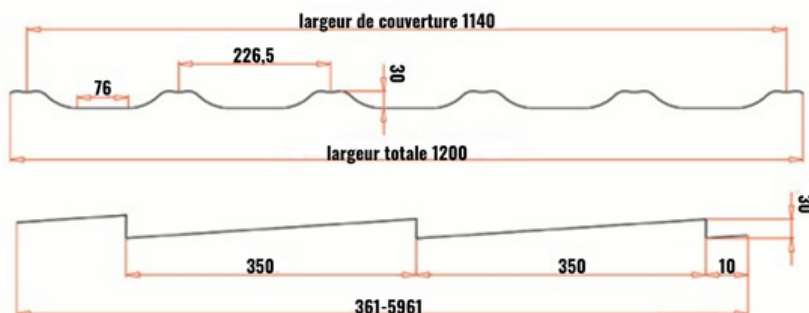

P-A

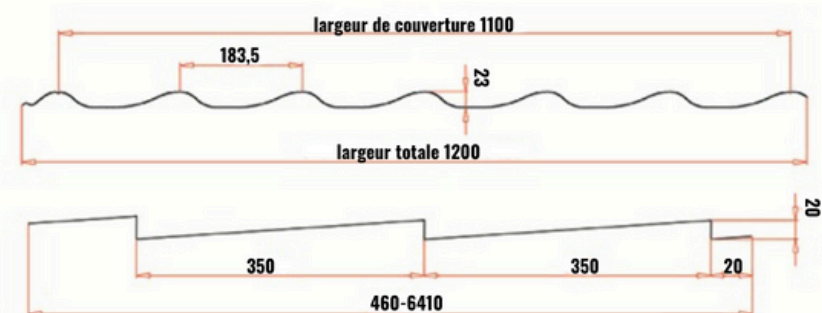

Feuilles de tôles plates disponibles dans une large gamme de couleurs et de matériaux (tels que l'aluzinc, le titane-zinc, le cuivre, etc.).

En plus des formats standard (125 x 200 cm), nous proposons également des découpes et des pliages sur mesure selon vos besoins.

Les différentes couleurs disponibles sur commande (uniquement RAL 7016 de stock) :

Revêtement brillant



Revêtement mat

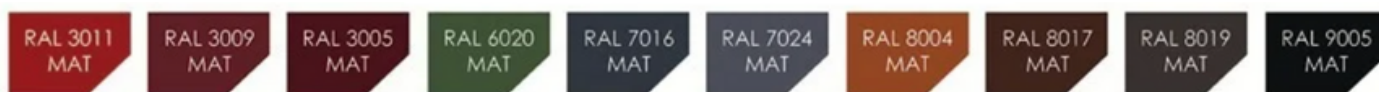



info@construkmania.com



7500 Tournai



+32 491 25 32 58



Uniquement sur rendez-vous du
lundi au samedi